

# Angular dispersion compensation for acousto-optic devices used for ultrashort-pulsed laser micromachining

B. K. A. Ngoi, K. Venkatakrishnan, B. Tan, P. Stanley and L. E. N. Lim

*PEN Centre, School of MPE, Nanyang Technological University, Singapore 639798*

**Abstract:** Ultrashort pulsed laser material processing is a new micromachining method that is gaining interest. Its capability of submicrometer machining has been proved. To obtain high speed and highly flexible beam steering, a two-axis acousto-optic deflector is employed. However, dispersion associated with acoustic-optic interaction will cause serious spatial deformation on the writing spot. The compensation for dispersion is proposed and studied. Experiments show promising results. An additional advantage of the proposed compensation method is that it can also precisely control the pulse number, and, hence improve the quality of ablation.

©2001 Optical Society of America

**OCIS codes:** (230.1040) Acousto-optical devices; (320.7160) Ultrafast technology

---

## References

1. X. Liu, D. Du. and G. Mourou, "laser ablation and micromachining with ultrashort laser pulses," IEEE J. Quantum Electron. 33, 1706—1716, (1997).
2. P. P. Pronko, S. K. Dutta, J. Squier, J. V. Rudd, D. Du, and G. Mourou, "Machining of submicron holes using a femtosecond laser at 800nm," Opt. Commun. 114, 106—110 (1995).
3. X. Liu, "Submicron lines in thin metal films micromachined by an ultrafast laser oscillator," Conference on Lasers and Electro-Optics (CLEO/U.S.), Vol. 6 of 1998 OSA Technical Digest Series (Optical Society of America, Washington, D.C. 1998), p511.
4. P. C. Allen and P. Buck, "Resolution performance of a 0.6NA, 364nm laser direct writer," Proc. SPIE, 1264, 454—465 (1990).

---

## 1. Introduction

It has been proved that ultrashort pulsed laser is superior to continuous-wave lasers in the area of material removal on a nanoscale level with a significant increase in resolution as a result of the unique characteristics of ultrashort pulsed laser ablation. Its capability of submicrometer machining by direct ablation has already been proved.<sup>[1-3]</sup>

Acousto-optic devices have widespread applications in the field of laser microfabrication and they are normally used for intensity modulation and laser beam steering. For example, an acousto-optic modulator (AOM) is used for the optical disk recording process to modulate the intensity of the writing beam based on the video or audio signal to be recorded. Acousto-optic deflectors (AODs) are commonly used in laser direct writing systems to provide flexible and high-speed beam scanning with high precision and accuracy.

We have developed a micromachining system using an ultrashort pulsed laser. To scan the beam with high precision and accuracy, AODs are used in this system. Unlike monochromatic lasers, the ultrashort pulsed laser has a spectral bandwidth of 10 nm. Hence, dispersion occurs when the laser beam transmits AODs, resulting in spatial deformation of the machining spot. Here we discuss the dispersion and its compensation using an AOM. An additional advantage of the proposed compensation method is that it can also precisely control the number of pulses and therefore improve the quality of ablation.

## 2. Beam Steering with an Acousto-Optic Deflector

To ablate submicrometer features using an ultrashort laser, we steer the beam with ultrahigh positional accuracy through a nonmechanical scanning system using a pair of AODs. Unlike

the usual setup and utilization of mechanical translational motion-axis stages or scanning mirrors driven by motors, AODs can achieve far superior performance with greater speed far better positioning accuracys and repeatability while the laser beam is rastering. AODs have been used in laser direct writing systems to achieve high speed as well as highly accurate and programmable beam scanning<sup>[4]</sup> and they are generally used for continuous-wave lasers or long pulsed lasers. They have not been used for ultrashort pulsed lasers and its related phenomenon has not been studied.

A single acousto-optic deflector is normally employed for one-axis scanning operation such as those commonly found in high-speed surface profilers. However, to create a pattern on the target object two-axis scanning is required, which necessitates the use of two AODs. These two AODs are mounted together with their optical axes perpendicular to each other with each AOD scanning in one axis.

The AODs that were used in this experimental setup were specially designed by use of TeO<sub>2</sub> crystals to provide extremely high accuracy of 100×10<sup>6</sup>ppm together with a minimum step size of a mere 7 nm. With an access time (time to scan from point to point) of just 9.32 μs and consequently a scanning rate as high as 100,000 points/s, no other mechanical scanning mechanism could match these deflectors.

### 3. Dispersion

The AOD acts as a moving grating. The scanning beam is its first diffraction order. The separation angle  $\theta$  between a zero-order beam and a first-order diffraction beam is expressed as

$$\theta = \lambda_0 f_a / v_a \quad (1)$$

where  $\lambda_0$  is the velocity of the incident light,  $f_a$  is the driving frequency of the deflector, and  $v_a$  is the wavelength of the acoustic wave that propagates in the crystal. An ultrashort pulsed laser is not a monochromatic light. It emits pulses with a much broader spectral bandwidth (approximately 10 nm) than the nanosecond or picosecond laser pulses that are typically used for machining. The lower wavelength portion of the spectrum bandwidth is deflected at an angle less than that of the higher wavelength portion of the spectrum, resulting in the dispersion of the laser beam. The dispersion angle can be obtained from separation angle  $\theta$ :

$$\Delta\theta = \lambda_1 f_a / v_a - \lambda_2 f_a / v_a = \Delta\lambda f_a / v_a \quad (2).$$

where  $\lambda_1$  and  $\lambda_2$  represent the highest and the lowest ports of the spectrum bandwidth respectively, and  $\Delta\lambda$  stands for the bandwidth of the spectrum.

The spatial profile of the laser beam is stretched in the direction of the acoustic wave, resulting in an elliptical beam, as illustrated in Fig. 1. We used two AODs for the micromachining system developed by us. Hence, dispersion occurs in both the X and Y axes. Also, the spatial profile of the laser beam will be stretched in both axes, resulting in an elliptical spot dispersed in a diagonal manner, as shown in Fig. 2. The final dispersion angle  $\Delta\theta$  can be obtained from dispersion angles in the X axis and the Y axis,  $\Delta\theta_X$  and  $\Delta\theta_Y$ .

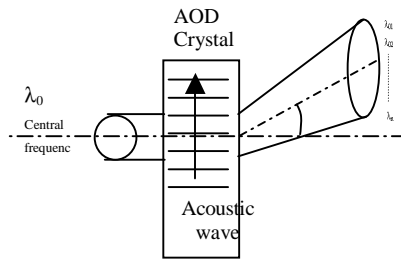

(a)

Fig. 1. Dispersion occurs after transmitting the AOD

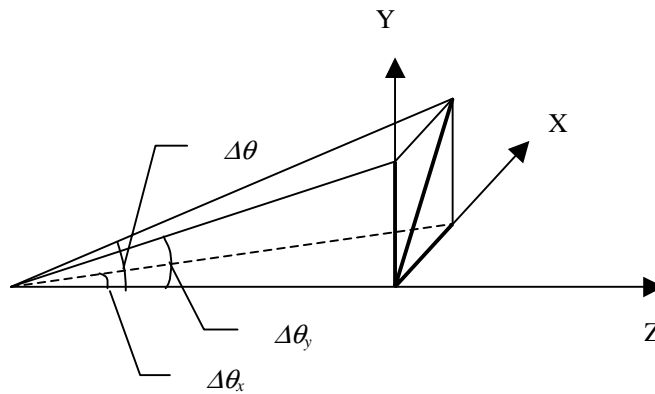

Fig. 2 Two axes dispersion

$$\Delta\theta = (\Delta\theta_x^2 + \Delta\theta_y^2)^{1/2} \quad (3)$$

Without dispersion the energy of the laser beam is concentrated at the central portion, the intensity peak. By carefully controlling the energy of the laser beam, one can produce feature of  $1/10^{\text{th}}$  of the spot size with a well-defined Gaussian profile. However, the wavelength dispersion of the laser beam disturbs the Gaussian distribution. It not only changes the beam shape but also disturbs the energy concentration. Therefore, the machining quality and resolution are affected.

#### 4. Compensation for Dispersion

To compensate for dispersion, a dispersible element must be used in a reverse way to recombine the dispersed spectrum. For an AOD, the most intuitive plan is to use an acousto-optic modulator AOM oriented in such a way that the acoustic wave travels in a direction opposite that of the AOD, as illustrated in Fig. 3. The acoustic crystal of both the AOD and the AOM should have the same specifications. To recollimate the dispersed beam, the AOM must be placed as close as possible to the AOD.

One AOM corrects the dispersion in one direction. The two-axis dispersion can be compensated by use of an identical set of two AOMs with the same properties (such as crystal type and central frequency) as the AODa, but with an opposite setup configuration.

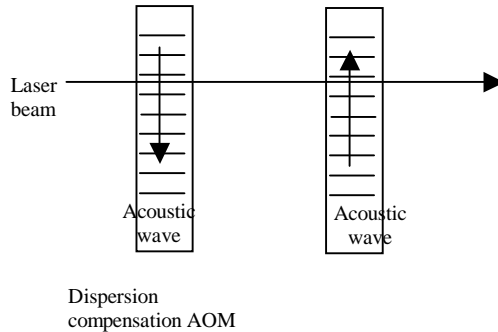

Fig. 3 Principle of compensation for dispersion caused by AOD

Subsequently, an alternative novel idea was proposed that simply employs a single AOM to correct the two-axis dispersion, to reduce the number of optical elements involved in a general optical system. This requires that the AOM be tilted in such a manner that its output beam will disperse with its major axis in the same direction as that of applied with two AODs. With this proposed configuration, the dispersion can be effectively recombined, forming a corrected collimated beam. This setup is illustrated in Fig. 4.

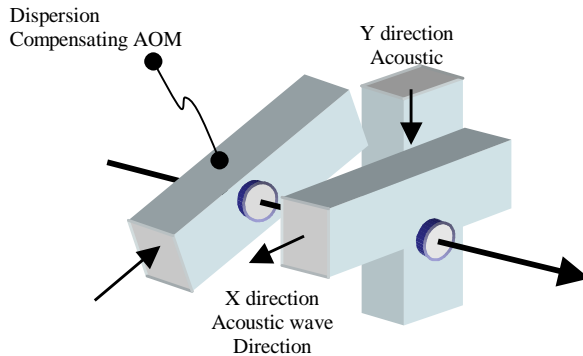

Fig. 4. Optimized Dispersion compensation. The final beam is corrected and compensated from the AOM. In the experiment, the tilting degree of the AOM lies approximately around 45°.

## 5. Error Analysis and Optimization

As far as the two-axis deflector is concerned, the angle of dispersion of the laser beam along the bandwidth of the driving frequency is calculated and plotted in Fig. 5. The figure shows that dispersion increases linearly with the increase in driving frequency in both scan axes. Error in the form of uncompensated dispersion in the complete scanning range can be calculated from

$$error = \Delta\theta_{AOM} - \Delta\theta \quad (4)$$

where  $\Delta\theta_{AOM}$  represents the dispersion after the use of AOM. Since the operation frequency of an AOM is set at the central frequency of the deflector, complete compensation is unachievable in the above mentioned experiments. The ratio of error to dispersion (error/dispersion) is given in Fig. 6. The figure shows that the minimum error is obtained while both deflectors are operated at the lower part of the frequency bandwidth. Error increases with an increase in driving frequency. The ratio of error to dispersion reaches 40%

at the higher part of the bandwidth, which means that, at this scanning area, the spatial deformation of the spot can be corrected by 60% only.

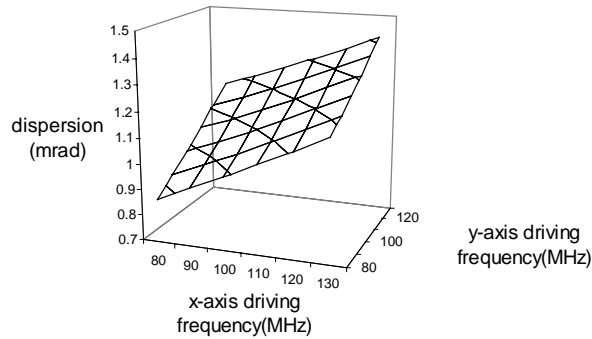

Fig. 5 Dispersion along the bandwidth of driving frequency

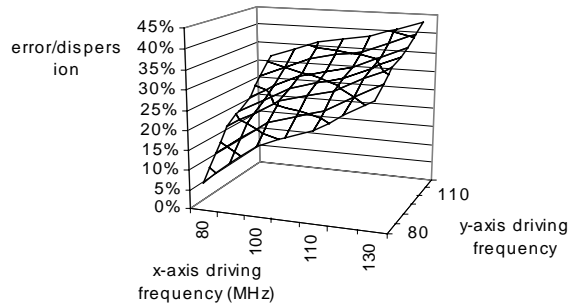

Fig. 6 Error of compensation along the bandwidth while the central frequency of AOM is 105MHz

For an AOD, normally the best performance, including intensity stability and spatial quality of the first-order diffraction, can be obtained at the center of the frequency bandwidth. To achieve the best machining quality, we usually locate the target surface at the center of the

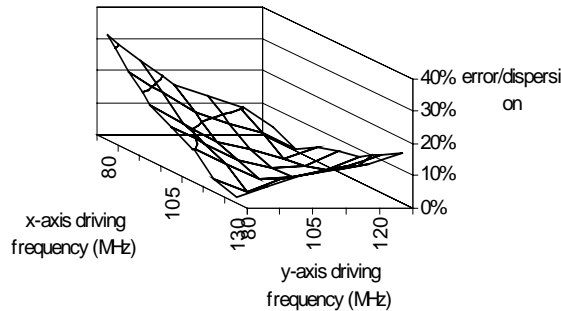

Fig. 7 Error of compensation along the bandwidth while the central frequency of AOM is 150MHz

scanning range. Therefore, complete compensation for dispersion is desired at the central part of the frequency bandwidth. The dispersion while both deflectors are operated at their central frequencies of 105.000 MHz is calculated as 1.142249 mrad. Dispersion of the AOM reachS 1.153846 mrad if it is driven by 150.000 MHz frequency. Hence, at this frequency a spot

completely free of dispersion can be expected at the central point of the scanning range. The ratio of error to dispersion under this condition is given in Fig. 7.

In addition, Fig. 7 reveals that the ratio of error to dispersion is controlled to less than 30% at a frequency of 150.000 MHz, whereas the ratio is greater than 40% at one corner of the scanning range when the frequency is 105.000 MHz. Moreover, the error at the central port (100.000 MHz~120.000 MHz) of the scanning range is less than 0.1 mrad and the uncompensated dispersion is less than 6%. Hence, for the experimental setup, optimized compensation can be achieved at a frequency of 150.000 MHz.

## 6. Experiments and Results

For this study, we used a chirped pulse amplification (CPA) Ti:sapphire system comprising of a pulse stretcher, a regenerative amplifier pumped by a Nd:YLF laser, and a compressor. This system produces pulses with 150 fs pulse duration at a 1KHz pulse repetition rate. The fundamental wavelength is 800 nm. The amplified pulses that comes from the compressor module enters through a second harmonic generator. The final machining beam has a 400 nm wavelength. Because of the group velocity difference of the optical elements, the pulse width stretches to 500 fs at the final machining point. However, we can compensate for most of the stretching if necessary.

The telecentric lens focuses the 6 mm-diameter laser beam to a spot size  $2.5 \mu\text{m}$  ( $1/e^2$  width) (measured from ablated pits). The specimen to be processed is a finely sputtered gold film with a  $1000 \text{ \AA}$  layer on a 3.0mm thick quartz substrate. Subsequently, the micromachined features are evaluated from the images obtained with the scanning electron-beam microscopy (SEM). Images were obtained at the central field of the scanning area.

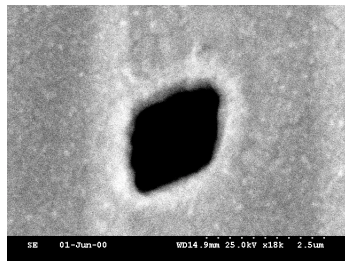

Fig. 8 Feature ablated on platinum film by dispersed laser spot (pulse energy of 60nJ).

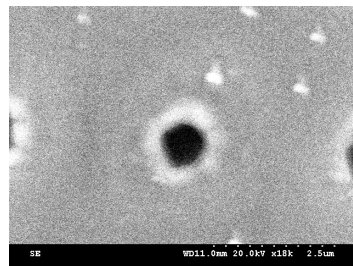

Fig. 9 Pit ablated on copper film. (pulse energy of 55nJ)

Some pits were created with the dispersed scanning laser beam. Fig. 8 is the SEM image of one of these pits. The pit has the shape of an ellipse. We also determined that it is difficult to minimize the size of the ablated feature. The smallest pit we obtained is around  $1 \mu\text{m}$ , which is  $1/5^{\text{th}}$  of the  $2.5 \mu\text{m}$  machining spot.

Some pits were ablated with the dispersion-compensated ultrashort pulsed laser beam. The image of one of these pits is shown in Fig. 9. The pit has a well-defined circular shape. From the result it is evident that the spatial deformation of the laser spot has been corrected completely. The machining resolution is also improved with the recollimated beam. The smallest pit we obtained is 200 nm in diameter, which is less than  $1/10^{\text{th}}$  of the focused machining spot.

## **7. Conclusion**

Laser direct writing by use of ultrashort pulsed lasers is superior over conventional laser direct writing. In the experimental setup that we developed, acousto-optic deflectors were used for the first time to our knowledge, to drive an ultrashort pulsed laser beam. Despite the superior performance over mechanical methods in terms of scan rate, position accuracy, and flexibility, acousto-optic deflectors cause beam dispersion which in turn affects the resolution and quality of micromachining. We have studied and reported on a correction method that demonstrates positive results.